



Operator's Manual

Serial Number Range

GS™-2669DC
GS™-3369DC
GS™-4069DC

from GS69F-18000

CE

with
Maintenance
Information

Original Instructions
Third Edition
First Printing
Part No. 1305655GT



Manufacturer:

Terex South Dakota, Inc.
500 Oakwood Road
Watertown, SD 57201, USA

Authorized representative:

Genie Industries B. V.
Boekerman 5
4751 XK OUD GASTEL
The Netherlands

Contents

Introduction	1
Symbol and Hazard Pictorials Definitions	5
General Safety	8
Personal Safety	11
Work Area Safety	12
Legend	19
Controls	20
Inspections	24
Operating Instructions	36
Transport and Lifting Instructions	45
Maintenance	48
Specifications	50

Copyright © 2011 by Trex Corporation

Third Edition: First Printing, August 2020

Genie is a registered trademark of Terex South Dakota, Inc. in the U.S.A. and many other countries. "GS" is a trademark of Terex South Dakota, Inc.

CE Complies with EC Directive 2006/42/EC
See EC Declaration of Conformity



Introduction

About this manual

Genie appreciates your choice of our machine for your application. Our number one priority is user safety, which is best achieved by our joint efforts. This book is an operation and daily maintenance manual for the user or operator of a Genie machine.

This manual should be considered a permanent part of your machine and should remain with the machine at all times. If you have any questions, contact Genie.

Product Identification

The machine serial number is located on the serial label.

Serial number stamped on chassis

Serial label (located under cover)

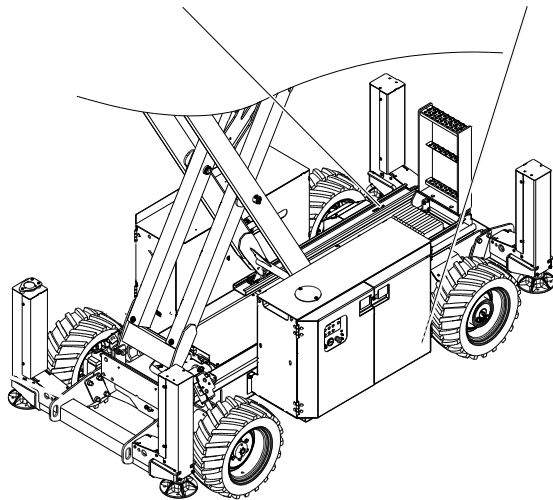

Intended Use and Familiarization Guide

The intended use of this machine is to lift personnel, including tools, and materials to an aerial work site. Before operating the machine, it's the operator's responsibility to read and understand this familiarization guide.

- Each person must be trained to operate a Mobile Elevating Work Platform (MEWP).
- Familiarization with the MEWP must be given to each person who is authorized, competent and trained.
- Only trained and authorized personnel should be permitted to operate the machine.
- The operator is responsible to read, understand, and obey the manufacturer's instructions and safety rules provided in the Operator's Manual.
- The Operator's Manual is located in the manual storage container, at the platform.
- For specific product applications, see **Contacting The Manufacturer**.

Introduction

Platform controls symbology and related machine movement:



Lift function enable button



Drive function enable button



Outrigger function button



Platform up/down (when lift function selected)



Drive forward/reverse (when drive function selected)



Steer right/left (when drive function selected)

Ground controls symbology and related machine movement:



Lift function enable button



Platform up/down button



Sequential functions and movement:

- Drive and steer.

Interlocked functions:

- Elevated drive speed.
- Elevated drive in an off-level condition.
- All platform and ground controls.

Limitations of use:

- The intended use of this machine is to lift personnel, including tools, and materials to an aerial work site.
- Do not elevate the platform unless the machine is on firm level ground.



Introduction

Bulletin Distribution and Compliance

Safety of product users is of paramount importance to Genie. Various bulletins are used by Genie to communicate important safety and product information to dealers and machine owners.

The information contained in the bulletins is tied to specific machines using the machine model and serial number.

Distribution of bulletins is based on the most current owner on record along with their associated dealer, so it is important to register your machine and keep your contact information up to date.

To ensure safety of personnel and the reliable continued operation of your machine, be sure to comply with the action indicated in a respective bulletin.

To view any open bulletins for your machine, visit us on the web at www.genielift.com.

Contacting the Manufacturer

At times it may be necessary to contact Genie. When you do, be ready to supply the model number and serial number of your machine, along with your name and contact information. At minimum, Genie should be contacted for:

- Accident reporting

- Questions regarding product applications and safety

- Standards and regulatory compliance information

- Current owner updates, such as changes in machine ownership or changes in your contact information. See Transfer of Ownership, below.

Transfer of Machine Ownership

Taking a few minutes to update owner information will ensure that you receive important safety, maintenance and operating information that applies to your machine.

Please register your machine by visiting us on the web at www.genielift.com or by calling us toll free at 1-800-536-1800.

Introduction



Danger

Failure to obey the instructions and safety rules in this manual will result in death or serious injury.

Do Not Operate Unless:

- ☑ You learn and practice the principles of safe machine operation contained in this operator's manual.
 - 1 **Avoid hazardous situations.**

Know and understand the safety rules before going on to the next section.

 - 2 Always perform a pre-operation inspection.
 - 3 Always perform function tests prior to use.
 - 4 Inspect the workplace.
 - 5 Only use the machine as it was intended.
- ☑ You read, understand and obey the manufacturer's instructions and safety rules—safety and operator's manuals and machine decals.
- ☑ You read, understand and obey employer's safety rules and worksite regulations.
- ☑ You read, understand and obey all applicable governmental regulations.
- ☑ You are properly trained to safely operate the machine.

Safety Sign Maintenance

Replace any missing or damaged safety signs. Keep operator safety in mind at all times. Use mild soap and water to clean safety signs. Do not use solvent-based cleaners because they may damage the safety sign material.

Hazard Classification

Decals on this machine use symbols, color coding, and signal words to identify the following:



Safety alert symbol—used to alert you to potential personal injury hazards. Obey all safety messages that follow this symbol to avoid possible injury or death.

▲ DANGER

Indicates a hazardous situation which, if not avoided, will result in death or serious injury.

▲ WARNING

Indicates a hazardous situation which, if not avoided, could result in death or serious injury.

▲ CAUTION

Indicates a hazardous situation which, if not avoided, could result in minor or moderate injury.











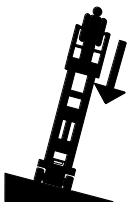

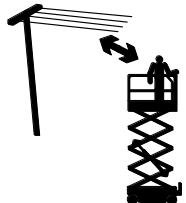

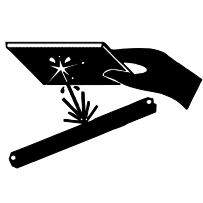
NOTICE

Indicates a property damage message.

Symbol and Hazard Pictorials Definitions



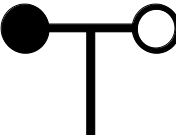





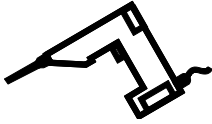
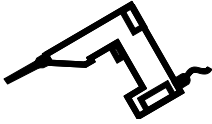

Read the operator's manual	Read the service manual	Crush hazard	Crush hazard	Collision hazard
Tip-over hazard	Tip-over hazard	Tip-over hazard	Tip-over hazard	Electrocution hazard
Electrocution hazard	Explosion hazard	Fire hazard	Burn hazard	Skin injection hazard
Engage safety arm	Keep away from moving parts	Keep clear of outriggers and tires	Move machine to level ground	Close chassis tray

Symbol and Hazard Pictorials Definitions

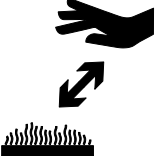
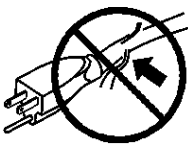
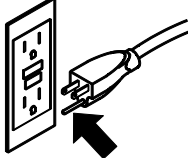
				
Lower the platform.	Do not set up where it cannot be leveled with outriggers	Maintain required clearance	Access by trained and authorized personnel only	Use a piece of cardboard or paper to search for leaks
				
Chock the wheels	Release brakes	Tiedown	Lanyard anchorage points	No smoking
				
Wheel load	Crush hazard	Side force	Wind speed	Outrigger load

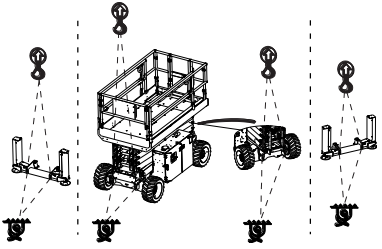
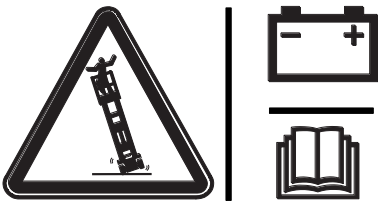

Symbol and Hazard Pictorials Definitions

 <p>Voltage rating for power to platform</p>	 <p>Pressure rating for air line to platform</p>	 <p>Maximum capacity</p>	 <p>Fall hazard</p>	 <p>100% Restraint</p>
 <p>Burn hazard stay away</p>	 <p>Fire hazard</p>	 <p>Fire hazard</p>	 <p>Collision hazard</p>	 <p>Lanyard anchorage points</p>
 <p>Platform overloaded</p>	 <p>Hold rail while lowering</p>	 <p>Crushing hazard</p>		
 <p>Transport diagram</p>	 <p>Battery as counterweight</p>			

General Safety

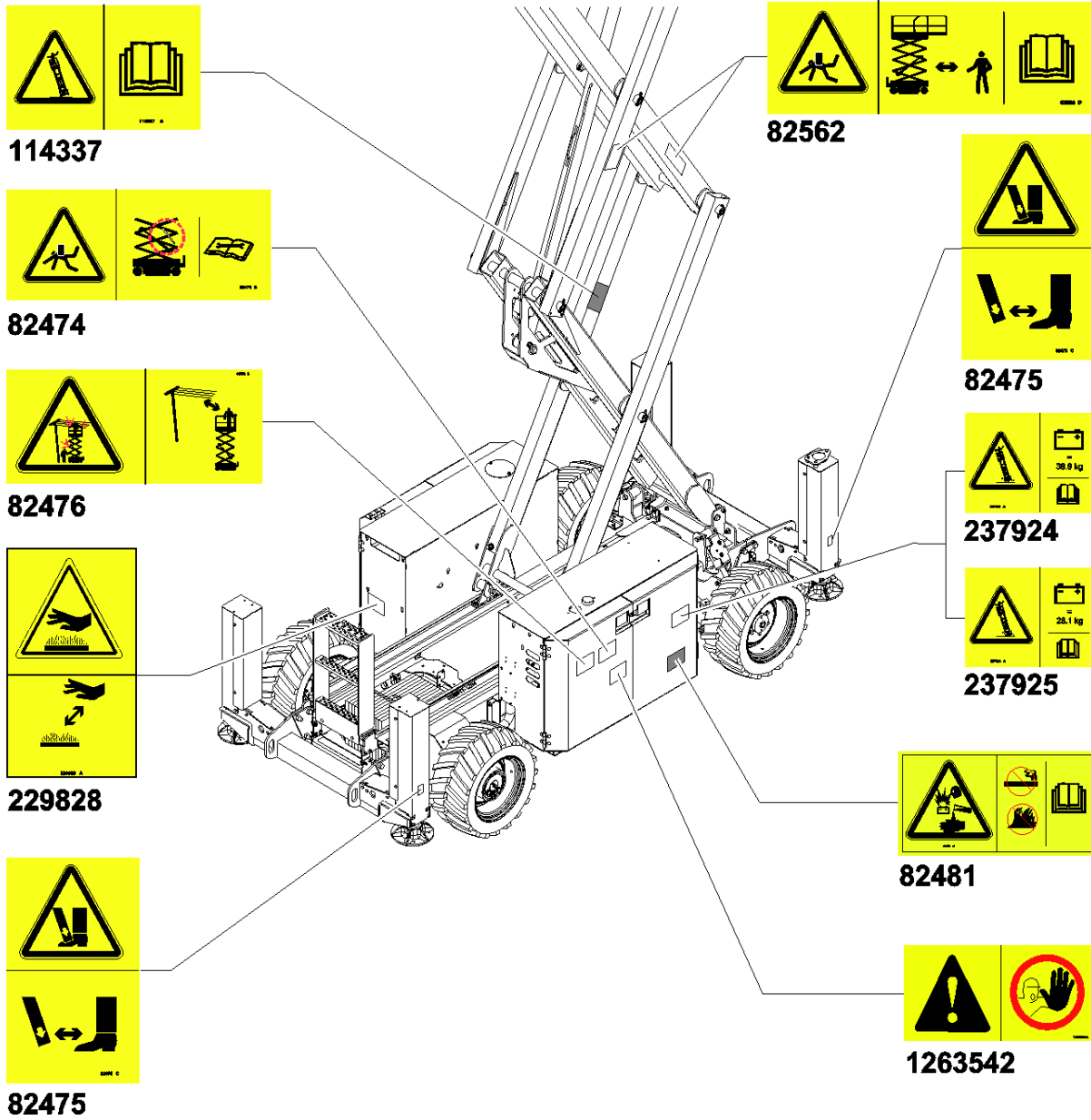

General Safety

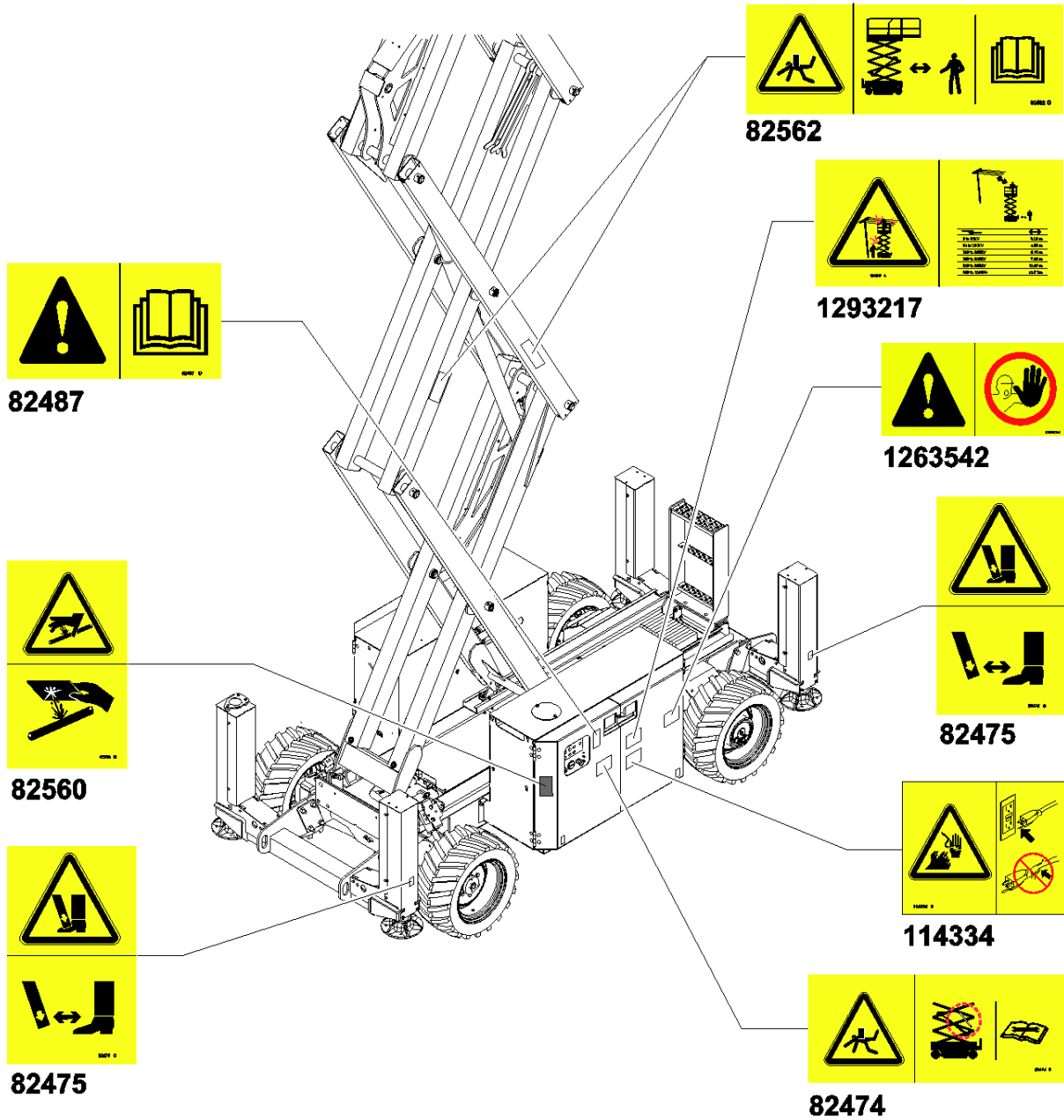

General Safety

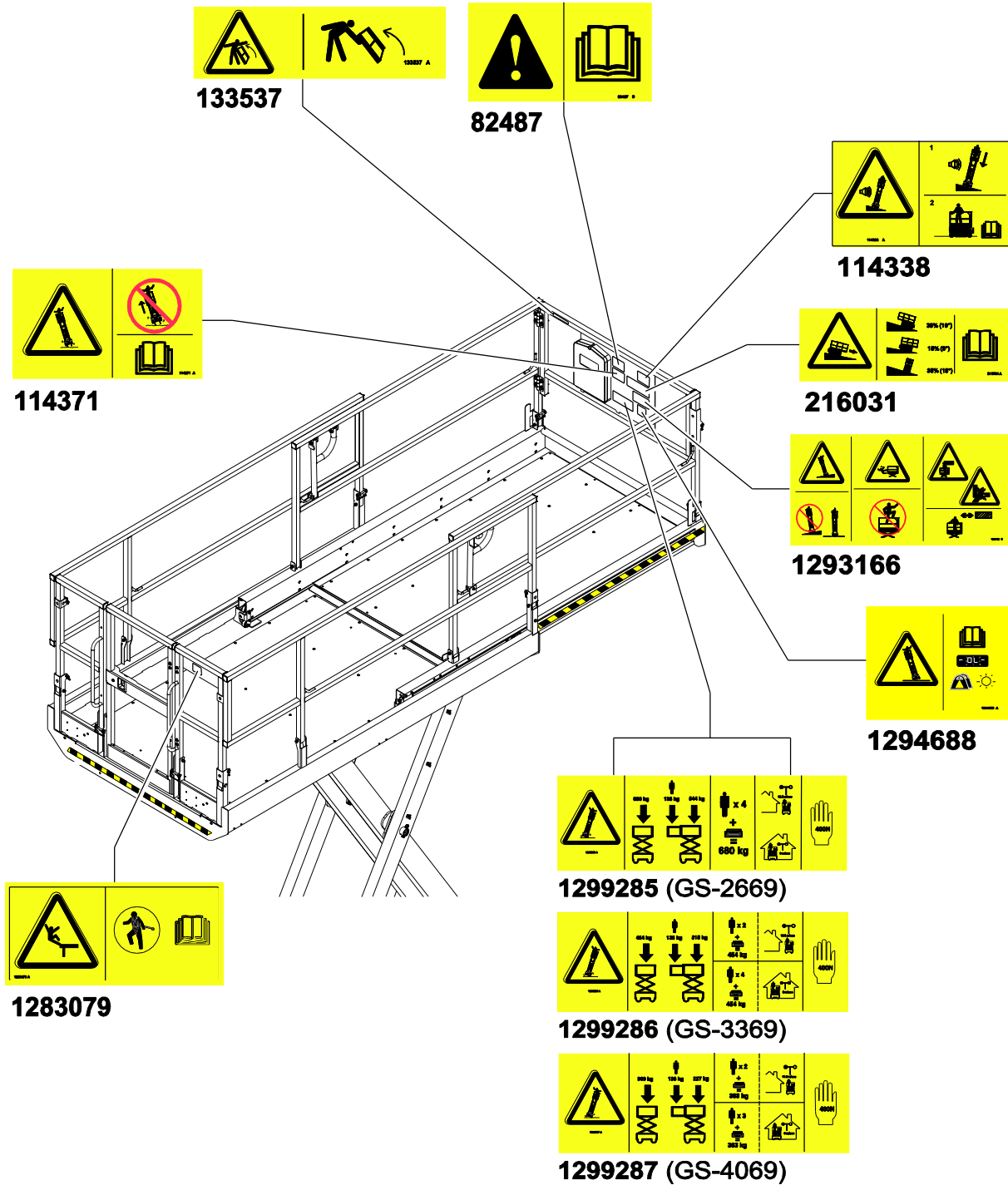



Personal Safety

Personal Fall Protection

Personal fall protection equipment (PFPE) is not required when operating this machine provided the operator remains inside the perimeter of the platform guardrail system. If PFPE is required by job site or employer rules, the following shall apply:

All PFPE must comply with applicable governmental regulations and must be inspected and used in accordance with the manufacturer's instructions.



Work Area Safety

⚠ Electrocuting Hazards

This machine is not electrically insulated and will not provide protection from contact with or proximity to electrical current.

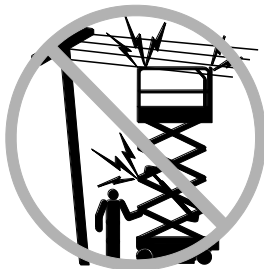

Obey all local and governmental regulations regarding required clearance from electrical power lines. At a minimum, the required clearance contained in the chart below must be followed.

Line Voltage	Required Clearance	
0 to 50KV	10 ft	3.05 m
50 to 200KV	15 ft	4.60 m
200 to 350KV	20 ft	6.10 m
350 to 500KV	25 ft	7.62 m
500 to 750KV	35 ft	10.67 m
750 to 1000KV	45 ft	13.72 m

Allow for platform movement, electrical line sway or sag, and beware of strong or gusty winds.

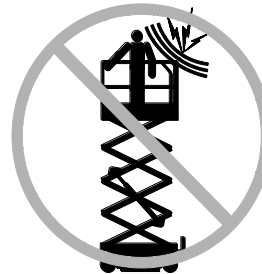

Keep away from the machine if it contacts energized power lines. Personnel on the ground or in the platform must not touch or operate the machine until energized power lines are shut off.

Do not operate the machine during lightning or storms.

Do not use the machine as a ground for welding.

⚠ Tip-over Hazards

Occupants, equipment and materials shall not exceed the maximum platform capacity or the maximum platform capacity of the platform extension.

Maximum capacity

Model	Platform extended			Maximum occupants
	Platform retracted	Platform only	Extension only	
GS-2669DC	1500 lbs/ 680 kg	1200 lbs/ 544 kg	300 lbs/ 136 kg	4
GS-3369DC	1000 lbs/ 454 kg	700 lbs/ 318 kg	300 lbs/ 136 kg	Indoor – 4 Outdoor – 2
GS-4069DC	800 lbs/ 363 kg	500 lbs/ 227 kg	300 lbs/ 136 kg	Indoor – 3 Outdoor – 2

Platform retracted



Platform extended

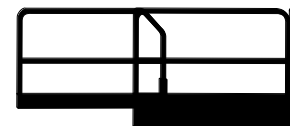

Extension only

Platform only

Work Area Safety



Do not raise the platform unless the machine is on a firm, level surface.

Do not raise the platform when wind speeds may exceed 28 mph / 12.5 m/s. If wind speeds exceed 28 mph / 12.5 m/s when the platform is raised, lower the platform and do not continue to operate the machine.



Do not depend on the tilt alarm as a level indicator. The tilt alarm sounds on the chassis only when the machine is on a severe slope.

If the tilt alarm sounds:

Lower the platform. Move the machine to a firm, level surface. If the tilt alarm sounds when the platform is raised, use extreme caution to lower the platform.

Do not alter or disable the limit switches or angle sensor.

Do not drive over 0.3 mph / 0.48 km/h with the platform raised.



Do not operate the machine in strong or gusty winds. Do not increase the surface area of the platform or the load. Increasing the area exposed to the wind will decrease machine stability.

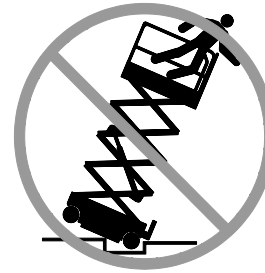

Use extreme care and slow speeds while driving the machine in the stowed position across uneven terrain, debris, unstable or slippery surfaces and near holes and drop-offs.

Do not use the platform controls to free a platform that is caught, snagged, or otherwise prevented from normal motion by an adjacent structure. All personnel must be removed from the platform before attempting to free the platform using the ground controls.

Do not drive the machine on or near uneven terrain, unstable surfaces or other hazardous conditions with the platform raised.



Work Area Safety

Do not use the machine as a crane.

Do not push the machine or other objects with the platform.

Do not contact adjacent structures with the platform.

Do not tie the platform to adjacent structures.

Do not place loads outside the platform perimeter.



Do not push off or pull toward any object outside of the platform.



Do not place or attach fixed or overhanging loads to any part of this machine.



Do not place ladders or scaffolds in the platform or against any part of this machine.

Maximum allowable side force – ANSI & CSA

GS-2669DC – 4 person	90 lbs / 400 N
GS-3369DC – 4 person, indoor	90 lbs / 400 N
GS-3369DC – 2 person, outdoor	90 lbs / 400 N
GS-4069DC – 3 person, indoor	90 lbs / 400 N
GS-4069DC – 2 person, outdoor	90 lbs / 400 N

Do not alter or disable machine components that in any way affect safety and stability.

Do not replace items critical to machine stability with items of different weight or specification.

Do not modify or alter a mobile elevating work platform without prior written permission from the manufacturer. Mounting attachments for holding tools or other materials onto the platform, toeboards, or guard rail system can increase the weight in the platform and the surface area of the platform or the load.

Do not transport tools and materials unless they are evenly distributed and can be safely handled by person(s) in the platform.

Do not use the machine on a moving or mobile surface or vehicle.

Be sure all tires are in good condition, castle nuts are properly tightened and cotter pins are properly installed.

Do not use batteries that weigh less than the original equipment. Batteries are used as counterweight and are critical to machine stability. For GS-4069 machines, each battery must weigh 88 lbs / 39.9 kg. For each GS-2669 and GS-3369 machine with high capacity battery option, each battery must weigh 88 lbs / 39.9 kg. For GS-2669 and GS-3369 machines with the standard battery option, each battery must weigh 62 lbs / 28.1 kg.

Work Area Safety

▲ Crushing Hazard

Keep hands and limbs out of scissors.

Keep hands clear when folding rails.



Do not work under the platform or in the scissor links without the safety arm in place.

Use common sense and planning when operating the machine with the controller from the ground. Maintain safe distances between the operator, the machine and fixed objects.

▲ Operation on Slopes Hazards

Do not drive the machine on a slope that exceeds the maximum uphill, downhill or side slope rating of the machine. Slope rating applies only to machines in the stowed position.

Maximum slope rating, stowed position

	Extension deck uphill	35% (19°)
	Extension deck downhill	15% (9°)
	Side slope	35% (19°)

Note: Slope rating is subject to ground conditions with one person in the platform and adequate traction. Additional platform weight may reduce slope rating. See Driving on a Slope in the Operating Instructions section.

▲ Fall Hazards

The guard rail system provides fall protection. If occupant(s) of the platform are required to wear personal fall protection equipment (PFPE) due to job site or employer rules, PFPE and its use shall be in accordance with the PFPE manufacturer's instructions and applicable governmental requirements. Use approved lanyard attachment point provided.



Do not sit, stand, or climb on the platform guard rails. Maintain a firm footing on the platform floor at all times.



Do not climb down from the platform when raised.

Keep the platform floor clear of debris.

Do not enter or exit the platform unless the machine is in the stowed position.

Attach the platform entry chain or close the entry gate before operating.

Do not operate the machine unless the guard rails are properly installed and the entry is secured for operation.

Work Area Safety

⚠ Collision Hazards

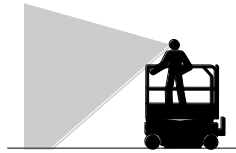

Be aware of limited sight distance and blind spots when driving or operating.

Be aware of extended platform position when moving the machine.

The machine must be on a level surface or secured before releasing the brakes.

Operators must comply with employer, job site, and governmental rules regarding use of personal protective equipment.



Check the work area for overhead obstructions or other possible hazards.



Be aware of crushing hazards when grasping the platform guard rail.

Observe and use color-coded direction arrows on the platform controls and the platform decal plate for drive and steer functions.



Do not lower the platform unless the area below is clear of personnel and obstructions.



Limit travel speed according to the condition of the ground surface, congestion, slope, location of personnel, and any other factors which may cause collision.

Do not operate a machine in the path of any crane or moving overhead machinery unless the controls of the crane have been locked out and/or precautions have been taken to prevent any potential collision.

No stunt driving or horseplay while operating a machine.



Work Area Safety

▲ Bodily Injury Hazard

Do not operate the machine with a hydraulic oil or air leak. An air leak or hydraulic leak can penetrate and/or burn skin.

Improper contact with components under any cover will cause serious injury. Only trained maintenance personnel should access compartments. Access by the operator is only advised when performing a pre-operation inspection. All compartments must remain closed and secured during operation.

▲ Explosion and Fire Hazards

Do not operate the machine or charge the battery in hazardous locations or locations where potentially flammable or explosive gases or particles may be present.

▲ Damaged Machine Hazards

Do not use a damaged or malfunctioning machine.

Conduct a thorough pre-operation inspection of the machine and test all functions before each work shift. Immediately tag and remove from service a damaged or malfunctioning machine.

Be sure all maintenance has been performed as specified in this manual and the appropriate Genie service manual.

Be sure all decals are in place and legible.

Be sure the operator's, safety, and responsibilities manuals are complete, legible, and in the storage container located on the machine.

▲ Component Damage Hazards

Do not use any battery charger greater than 48V to charge the batteries.

Do not use the machine as a ground for welding.

Lockout After Each Use

- 1 Select a safe parking location—firm level surface, clear of obstruction and traffic.
- 2 Lower the platform.
- 3 Turn the key switch to the off position and remove the key to secure from unauthorized use.
- 4 Charge the batteries.

Work Area Safety

⚠ Battery Safety

Burn Hazards



Batteries contain acid. Always wear protective clothing and eye wear when working with batteries.

Avoid spilling or contacting battery acid. Neutralize battery acid spills with baking soda and water.

Do not expose the batteries or the charger to water or rain during charging.

Explosion Hazards

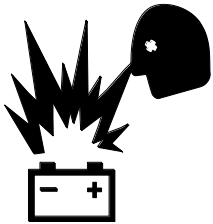

Keep sparks, flames, and lighted tobacco away from batteries. Batteries emit explosive gas.

The battery tray should remain open during the entire charging cycle.



Do not contact the battery terminals or the cable clamps with tools that may cause sparks.



Component Damage Hazard

Do not use any battery charger greater than 48V to charge the batteries.

Electrocution/Burn Hazards



Connect the battery charger to a grounded, AC 3-wire electrical outlet only.

Inspect daily for damaged cords, cables and wires. Replace damaged items before operating.

Avoid electrical shock from contact with battery terminals. Remove all rings, watches and other jewelry.

Tip-over Hazard

Do not use batteries that weigh less than the original equipment. Batteries are used as counterweight and are critical to machine stability. For GS-4069 machines, each battery must weigh 88 lbs / 39.9 kg. For each GS-2669 and GS-3369 machine with high capacity battery option, each battery must weigh 88 lbs / 39.9 kg. For GS-2669 and GS-3369 machines with the standard battery option, each battery must weigh 62 lbs / 28.1 kg.

Lifting Hazard

Use the appropriate number of people and proper lifting techniques when lifting batteries.

Legend

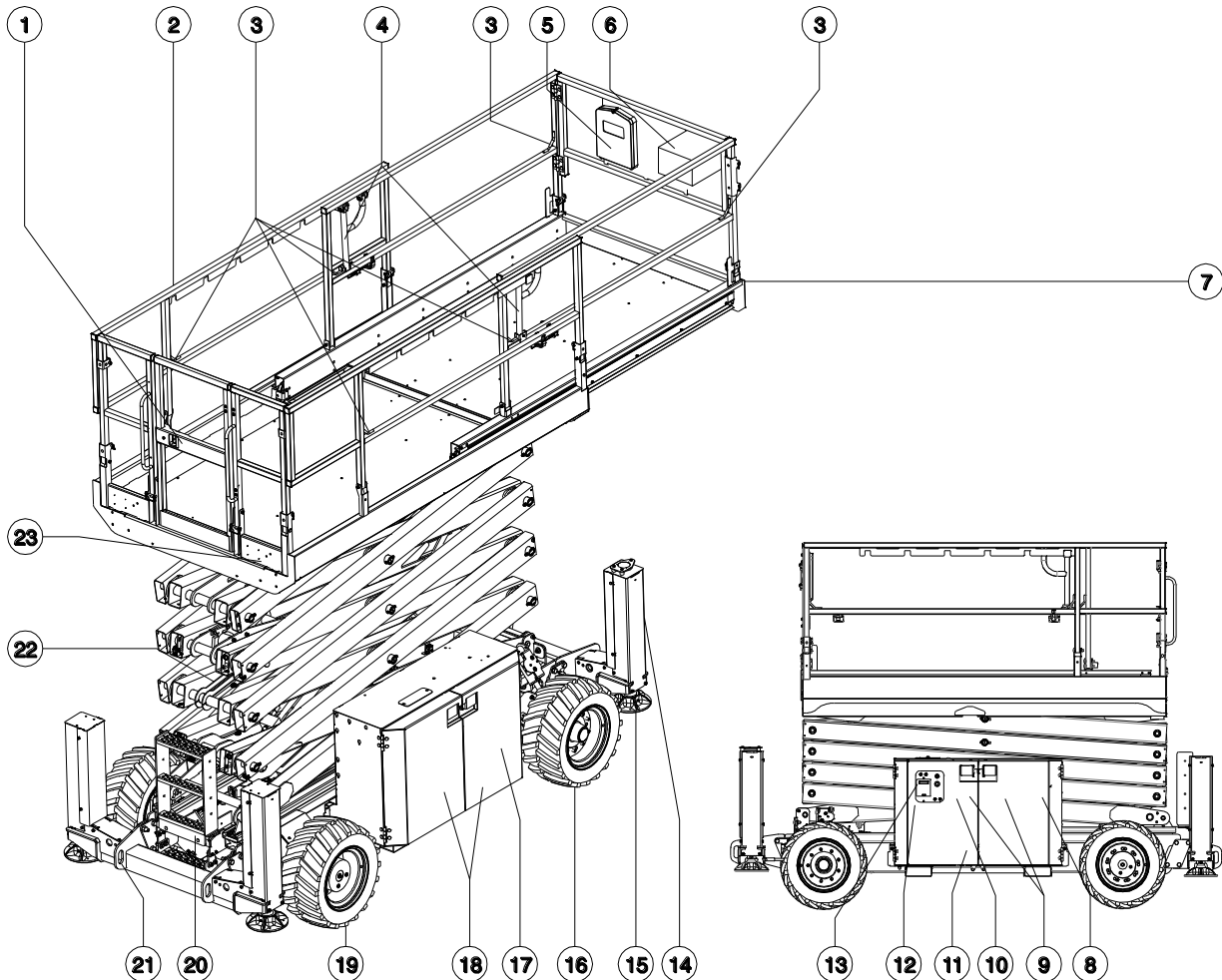

- | | |
|--|--|
| 1 Platform entry gate | 12 Hydraulic oil level indicator (behind cover) |
| 2 Platform guard rails | 13 Ground controls with LCD readout screen |
| 3 Lanyard anchorage points | 14 Outrigger housing (if equipped with outriggers) |
| 4 Platform extension lock handle | 15 Outrigger footpad (if equipped with outriggers) |
| 5 Manual storage container | 16 Steer tire |
| 6 Platform controls | 17 Inverter (optional) |
| 7 Platform extension | 18 Battery compartment covers |
| 8 Battery charger (behind cover at the ground controls side) | 19 Non-steer tire |
| 9 Ground controls side cover | 20 Entry ladder |
| 10 Hydraulic tank (behind cover) | 21 Transport tie-down |
| 11 Tilt alarm (behind cover) | 22 Safety arm |
| | 23 GFCI outlet |

Controls

The ground control station is to be used as a means to raise the platform for function tests and for storage purposes. The ground control station can be used in the event of an emergency to rescue an incapacitated person in the platform.

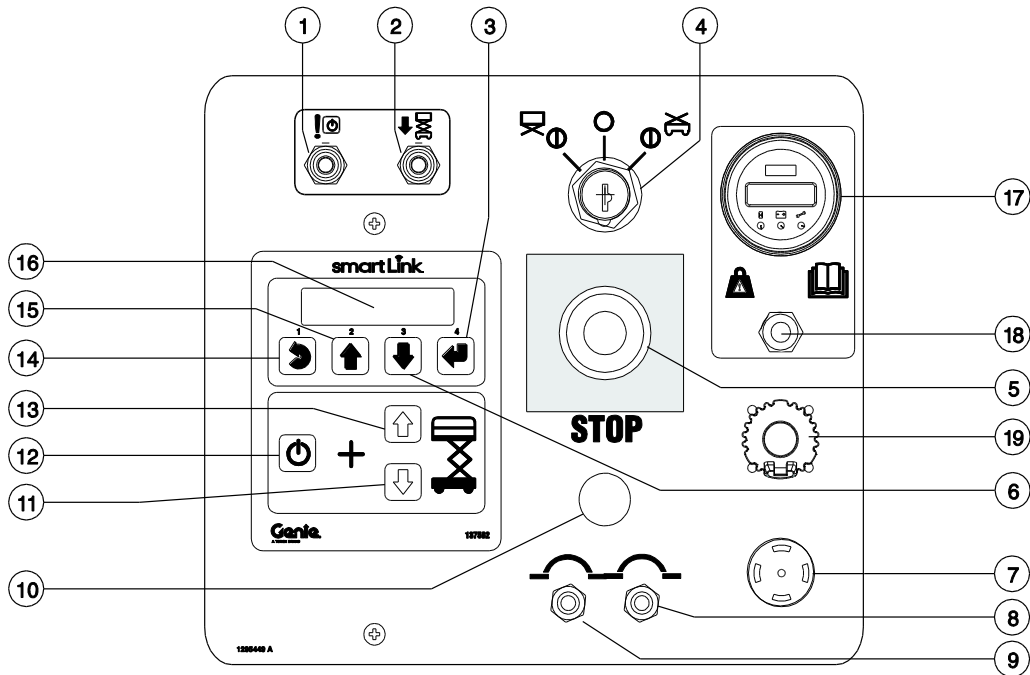

Ground Control Panel

- | | |
|--|--|
| <p>1 Function enable toggle switch for emergency lowering</p> <p>2 Emergency lowering toggle switch</p> <p>3 Menu enter button</p> <p>4 Key switch for platform/off/ground selection
Turn the key switch to the platform position and the platform controls will operate. Turn the key switch to the off position and the machine will be off. Turn the key switch to the ground position and the ground controls will operate.</p> <p>5 Red Emergency Stop button
Push in the red Emergency Stop button to the off position to stop all functions. Pull out the red Emergency Stop button to the on position to operate the machine.</p> <p>6 Menu down button</p> <p>7 Alarm</p> | <p>8 7A breaker for controls circuit</p> <p>9 15A breaker for controls circuit</p> <p>10 Platform down button</p> <p>11 Lift function enable button
Press and hold this button to activate the lift function.</p> <p>12 Platform up button</p> <p>13 Menu escape button</p> <p>14 Menu up button</p> <p>15 LCD diagnostic readout</p> <p>16 Load Sense LED display (see service manual for details)</p> <p>17 Load Sense Calibration switch (see service manual for details)</p> <p>18 Tech Pro Link Connector</p> |
|--|--|

Controls

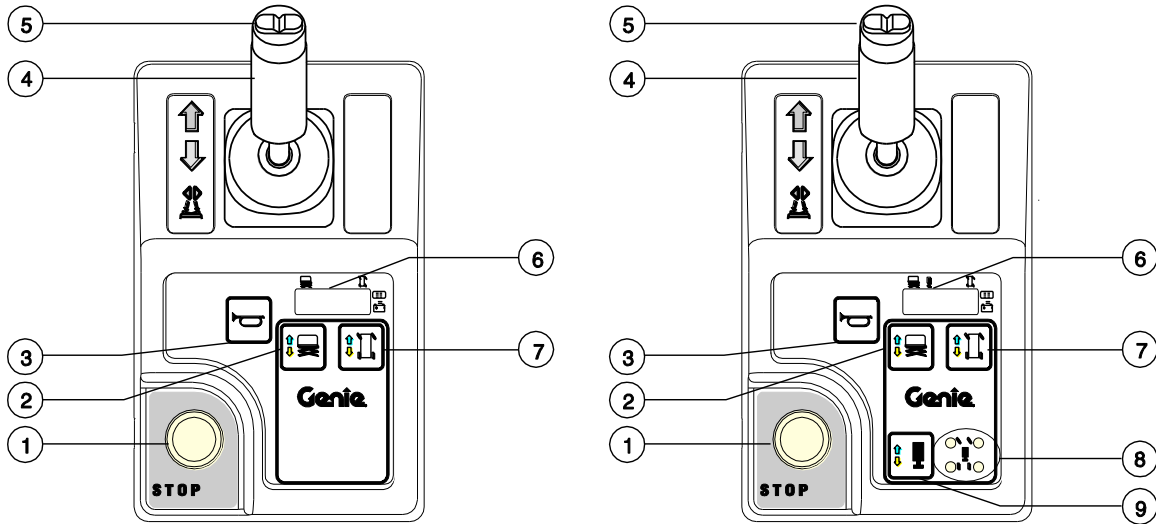

Platform Control Panel

Controls

1 Red Emergency Stop button

Push in the red Emergency Stop button to the off position to stop all functions. Pull out the red Emergency Stop button to the on position to operate the machine.

2 Lift function button

Push this button to activate the lift function.

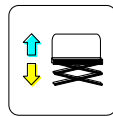

3 Horn button

Press the horn button and the horn will sound. Release the horn button and the horn will not sound.



4 Proportional control handle and function enable switch for drive, steer, lift and outrigger functions

Lift function: Press and hold the function enable switch to enable the lift function on the platform control handle. Move the control handle in the direction indicated by the blue arrow and the platform will raise. Move the control handle in the direction indicated by the yellow arrow and the platform will lower. The descent alarm should sound while the platform is lowering.

Drive function: Press and hold the function enable switch to enable the drive function on the platform control handle. Move the control handle in the direction indicated by the blue arrow on the control panel and the machine will move in the direction that the blue arrow points. Move the control handle in the direction indicated by the yellow arrow on the control panel and the machine will move in the direction that the yellow arrow points.

Outrigger function: Press and hold the function enable switch to enable the outrigger function on the platform control handle. Move the control handle in the direction indicated by the blue arrow and the outriggers will retract. Move the control handle in the direction indicated by the yellow arrow and the outriggers will extend.

Controls

5 Thumb rocker switch for steer function

Press the left side of the thumb rocker and the machine will turn in the direction the blue triangle points on the platform control panel.



Press the right side of the thumb rocker and the machine will turn in the direction the yellow triangle points on the platform control panel.



6 LED diagnostic readout, battery charge indicator and lift/drive mode indicator

7 Drive function button

Push this button to activate the drive function.

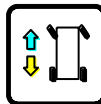

8 Outrigger indicator lights

During outrigger extension, lights flash green. As each outrigger contacts the ground, lights turn solid green. Any time the outrigger extension procedure is interrupted, the lights will flash green indicating the outriggers are not contacting the ground or the outriggers are not fully deployed. During outrigger retraction lights turn solid green. As each outrigger fully retracts, lights turn off. Lights will turn solid red, indicating the corresponding outrigger is at end of stroke.

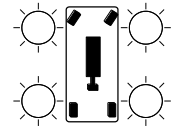

9 Outrigger function button

Press this button to activate the outrigger function.

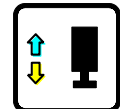

Inspections



Do Not Operate Unless:

- ☑ You learn and practice the principles of safe machine operation contained in this operator's manual.
 - 1 Avoid hazardous situations.
 - 2 **Always perform a pre-operation inspection.**

Know and understand the pre-operation inspection before going on to the next section.

 - 3 Always perform function tests prior to use.
 - 4 Inspect the workplace.
 - 5 Only use the machine as it was intended.

Pre-operation Inspection Fundamentals

It is the responsibility of the operator to perform a pre-operation inspection and routine maintenance.

The pre-operation inspection is a visual inspection performed by the operator prior to each work shift. The inspection is designed to discover if anything is apparently wrong with a machine before the operator performs the function tests.

The pre-operation inspection also serves to determine if routine maintenance procedures are required. Only routine maintenance items specified in this manual may be performed by the operator.

Refer to the list on the next page and check each of the items.

If damage or any unauthorized variation from factory delivered condition is discovered, the machine must be tagged and removed from service.

Repairs to the machine may only be made by a qualified service technician, according to the manufacturer's specifications. After repairs are completed, the operator must perform a pre-operation inspection again before going on to the function tests.

Scheduled maintenance inspections shall be performed by qualified service technicians, according to the manufacturer's specifications and the requirements listed in the responsibilities manual.



Inspections

Pre-operation Inspection

- Be sure that the operator's, safety, and responsibilities manuals are complete, legible and in the storage container located in the platform.
- Be sure that all decals are legible and in place. See Inspections section.
- Check for hydraulic oil leaks and proper oil level. Add oil if needed. See Maintenance section.
- Check for battery fluid leaks and proper fluid level. Add distilled water if needed. See Maintenance section.

Check the following components or areas for damage, improperly installed, or missing parts and unauthorized modifications:

- Electrical components, wiring, and electrical cables
- Hydraulic hoses, fittings, cylinders, and manifolds
- Drive motors
- Wear pads
- Tires and wheels
- Outrigger limit switches, angle sensor, alarms and horn
- Alarms and beacons (if equipped)
- Nuts, bolts and other fasteners
- Brake release components
- Safety arm
- Platform extension

- Scissor pins and retaining fasteners
- Lanyard anchorage points
- Platform control joystick
- Outrigger housing and footpads (if equipped)
- Battery pack and connections
- Ground strap
- Platform entry gate
- Inverter (if equipped)
- Outrigger housing and footpads (if equipped)

Check entire machine for:

- Cracks in welds or structural components
- Dents or damage to machine
- Excessive rust, corrosion or oxidation
- Verify that all structural and other critical components are present and all associated fasteners and pins are in place and properly tightened.
- Be sure side rails are installed and bolts are fastened.

Note: If the platform must be raised to inspect the machine, make sure the safety arm is in place. See Operating Instructions section.

Inspections



Do Not Operate Unless:

- You learn and practice the principles of safe machine operation contained in this operator's manual.
 - 1 Avoid hazardous situations.
 - 2 Always perform a pre-operation inspection.
 - 3 Always perform function tests prior to use.**

Know and understand the function tests before going on to the next section.

- 4 Inspect the workplace.
- 5 Only use the machine as it was intended.

Function Test Fundamentals

The function tests are designed to discover any malfunctions before the machine is put into service. The operator must follow the step-by-step instructions to test all machine functions.

A malfunctioning machine must never be used. If malfunctions are discovered, the machine must be tagged and removed from service. Repairs to the machine may only be made by a qualified service technician, according to the manufacturer's specifications.

After repairs are completed, the operator must perform a pre-operation inspection and function tests again before putting the machine into service.



Inspections

At the Ground Controls

- 1 Select a test area that is firm, level and free of hazards.
- 2 Be sure the batteries are connected.
- 3 Pull out the platform and ground red Emergency Stop button to the on position.
- 4 Turn the key switch to ground control.
- 5 Observe the diagnostic LED readout on the platform controls.
- ⊙ Result: The LED should look like the picture below.



- 6 Observe the diagnostic LCD readout on the ground controls.
- ⊙ Result: The LCD should display the model and hour meter.

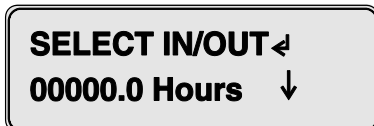

Test Emergency Stop

- 7 Push in the ground red Emergency Stop button to the off position.
- ⊙ Result: No functions should operate.
- 8 Pull out the red Emergency Stop button to the on position.

Test the Up/Down Functions

The audible warnings on this machine and the standard horn all come from the same central alarm. The horn is a constant tone. The descent alarm sounds at 60 beeps per minute. The alarm sounds at 180 beeps per minute when the machine is not level.

- 9 Do not press the lift function enable button.
- 10 Press the platform up or platform down button.
- ⊙ Result: The lift function should not operate.
- 11 Do not press the platform up or platform down buttons.
- 12 Press the lift function enable button.
- ⊙ Result: The lift function should not operate.
- 13 Press and hold the lift function enable button, and press the platform up button.
- ⊙ Result: The platform should raise.
- 14 Press and hold the lift function enable button, and press the platform down button.
- ⊙ Result: The platform should lower. The descent alarm should sound while the platform is lowering.



Inspections

Test Auxiliary Lowering

- 15 Activate the up function by pressing the lift enable button and platform up button, and raise the platform approximately 2 ft. / 60 cm.
- 16 Push in the ground red Emergency Stop button to the off position.
- 17 Pull out the red Emergency Stop button to the on position.
- 18 Move and hold the auxiliary lowering function enable toggle switch.
- 19 Move and hold the auxiliary lowering toggle switch.
- ⦿ Result: The platform should lower. The descent alarm will not sound.
- 20 Turn the key switch to platform control.

At the Platform Controls

Test Emergency Stop

- 21 Push in the platform red Emergency Stop button to the off position.
- ⦿ Result: No functions should operate.

Test the Horn

- 22 Pull out the red Emergency Stop button to the on position.
- 23 Press the horn button.
- ⦿ Result: The horn should sound.

Test the Function Enable Switch and the Up/Down Functions

- 24 Do not hold the function enable switch on the control handle.
- 25 Slowly move the control handle in the direction indicated by the blue arrow, then in the direction indicated by the yellow arrow.
- ⦿ Result: No functions should operate.
- 26 Press the lift function button.
- 27 Wait seven seconds for the lift function to time out.
- 28 Slowly move the control handle in the direction indicated by the blue arrow, then in the direction indicated by the yellow arrow.
- ⦿ Result: The lift function should not operate.
- 29 Press the lift function button.
- 30 Press and hold the function enable switch on the control handle. Slowly move the control handle in the direction indicated by the blue arrow.
- ⦿ Result: The platform should raise.
- 31 Release the control handle.
- ⦿ Result: The platform should stop raising.
- 32 Press and hold the function enable switch on the control handle. Slowly move the control handle in the direction indicated by the yellow arrow.
- ⦿ Result: The platform should lower. The descent alarm should sound while the platform is lowering.



Inspections

Test the Drive Function Button

- 33 Press the drive function button (if equipped).



- 34 Wait seven seconds for the drive function to time out. Slowly move the control handle in the direction indicated by the blue arrow, then in the direction indicated by the yellow arrow.

- ⦿ Result: No functions should operate.

Test the Steering

Note: When performing the steer and drive function tests, stand in the platform facing the steer end of the machine.

- 35 Press the drive function button (if equipped).



- 36 Press and hold the function enable switch on the control handle.
- 37 Press the thumb rocker switch on top of the control handle in the direction indicated by the blue triangle on the control panel.
- ⦿ Result: The steer wheels should turn in the direction indicated by the blue triangle.
- 38 Press the thumb rocker switch on top of the control handle in the direction indicated by the yellow triangle, on the control panel.
- ⦿ Result: The steer wheels should turn in the direction indicated by the yellow triangle.

Test Drive and Braking

- 39 Press the drive function button (if equipped).



- 40 Press and hold the function enable switch on the control handle.
- 41 Slowly move the control handle in the direction indicated by the blue arrow on the control panel until the machine begins to move, then return the control handle to the center position.

- ⦿ Result: The machine should move in the direction that the blue arrow points on the control panel, then come to an abrupt stop when the control handle is returned to the center position.

- 42 Slowly move the control handle in the direction indicated by the yellow arrow on the control panel until the machine begins to move, then return the control handle to the center position.

- ⦿ Result: The machine should move in the direction that the yellow arrow points on the control panel, then come to an abrupt stop when the control handle is returned to the center position.

Note: The brakes must be able to hold the machine on any slope it is able to climb.

Inspections

Test the Tilt Sensor Operation

Note: Perform this test from the ground with the platform controller. Do not stand in the platform.

- 43 Fully lower the platform.
- 44 Place a 2x4 or similar piece of wood under both wheels on one side and drive the machine up onto them.
- 45 Raise the platform approximately 7 ft / 2.13 m.
- ⦿ Result: The platform should stop and the tilt alarm will sound at 180 beeps per minute. The platform controls LED readout should display LL and the ground controls LCD should display LL: Machine Tilted.

- 46 Press the drive function button (if equipped).



- 47 Press and hold the function enable switch on the control handle.
- 48 Move the control handle in the direction indicated by the blue arrow, then move the control handle in the direction indicated by the yellow arrow.
- ⦿ Result: The drive function should not work in either direction.
- 49 Lower the platform and remove both pieces of wood.

Test Elevated Drive Speed

- 50 Raise the platform approximately 4 ft / 1.2 m from the ground.

- 51 Press the drive function button (if equipped).



- 52 Press and hold the function enable switch on the control handle. Slowly move the control handle to full drive position.

- ⦿ Result: The maximum achievable drive speed with the platform raised should not exceed 0.44 ft / 13 cm per second.

If the drive speed with the platform raised exceeds 0.44 ft / 13 cm per second, immediately tag and remove the machine from service.

Inspections

Test Stowed Drive Speed

53 Press and hold the lift function enable button, and press the platform down button.

⦿ Result: The platform should lower.

54 Press and hold the drive/steer function enable switch on the control handle. Slowly move the control handle to full drive position in the direction indicated by the blue arrow.

⦿ Result: The maximum achievable drive speed with the platform stowed should not exceed 6.6 ft / 2 m per second.

If the drive speed with the platform stowed exceeds 6.6 ft / 2 m per second, immediately tag and remove the machine from service.

55 Press and hold the drive/steer function enable switch on the control handle. Slowly move the control handle to full drive position in the direction indicated by the yellow arrow.

⦿ Result: The maximum achievable drive speed with the platform stowed should not exceed 4.4 ft / 1.34 m per second.

If the drive speed in reverse with the platform stowed exceeds 4.4 ft / 1.34 m per second, immediately tag and remove the machine from service.

Test the Outrigger System (if equipped)

56 Press the outrigger function button. On the LCD screen, a circle below the outrigger function symbol will turn on.

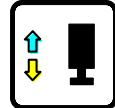

If the control handle is not moved within seven seconds of pushing the outrigger function button, the circle below the outrigger function symbol will turn off and outrigger function will not operate. Press the outrigger function button again.

57 Press and hold the function enable switch on the control handle.

58 Move the control handle in the direction indicated by the yellow arrow.

⦿ Result: The outriggers should extend. The individual outrigger indicator lights will flash green as the corresponding outrigger extends.

59 Continue holding the control handle in the direction indicated by the yellow arrow until all outrigger indicator lights turn solid green and a long beep is heard from the platform controls alarm. The machine is now level. At this point, the drive and steer functions are disabled.

Note: If the control handle is released too soon during extension, the outrigger indicator lights will continue to flash green, indicating the outriggers are not contacting the ground.

Note: If the control handle is released too soon after the outriggers have contacted the ground, a long beep will not be heard at the platform controls and the outrigger indicator lights will be solid green. If a long beep is not heard and the outrigger indicator lights are solid green, this condition may indicate the outriggers are not fully deployed or the machine is not level.



Inspections

- 60 Press the drive function button.
- 61 Press and hold the function enable switch on the control handle.
- 62 Slowly move the control handle in the direction indicated by the blue arrow, then in the direction indicated by the yellow arrow.
- ⦿ Result: The machine should not move in the directions indicated by the blue and yellow arrows.
- 63 Press the drive function button.
- 64 Press and hold the function enable switch on the control handle.
- 65 Press the thumb rocker switch on top of the control handle in the direction indicated by the blue and yellow triangles on the control panel.
- ⦿ Result: The steer wheels should not turn in the directions indicated by the blue and yellow triangles.
- 66 Raise the platform.
- ⦿ Result: The platform should raise. Raise the platform to approximately 8 ft / 2.4 m and stop.
- 67 Fully lower the platform.
- 68 Press the outrigger function button.
- 69 Wait seven seconds for the outrigger function enable to time out.
- 70 Slowly move the control handle in the direction indicated by the blue arrow, then in the direction indicated by the yellow arrow.
- ⦿ Result: The outriggers should not retract.
- 71 Press the outrigger function button.
- 72 Move the control handle in the direction indicated by the blue arrow.
- ⦿ Result: The outriggers should retract. The individual outrigger indicator lights will turn solid green as the corresponding outrigger retracts.
- 73 Continue holding the control handle until the outriggers are completely retracted. Release the control handle when all outrigger indicator lights turn off. All functions are now restored.

Note: If the control handle is released too soon during retraction, the outrigger indicator lights will flash green, indicating the outriggers are not fully retracted.

Inspections



Do Not Operate Unless:

- You learn and practice the principles of safe machine operation contained in this operator's manual.
 - 1 Avoid hazardous situations.
 - 2 Always perform a pre-operation inspection.
 - 3 Always perform function tests prior to use.
 - 4 Inspect the workplace.**

Know and understand the workplace inspection before going on to the next section.
 - 5 Only use the machine as it was intended.

Workplace Inspection Checklist

Be aware of and avoid the following hazardous situations:

- drop-offs or holes
- bumps, floor obstructions, or debris
- sloped surfaces
- unstable or slippery surfaces
- overhead obstructions and high voltage conductors
- hazardous locations
- inadequate surface support to withstand all load forces imposed by the machine
- wind and weather conditions
- the presence of unauthorized personnel
- other possible unsafe conditions

Workplace Inspection Fundamentals

The workplace inspection helps the operator determine if the workplace is suitable for safe machine operation. It should be performed by the operator prior to moving the machine to the workplace.

It is the operator's responsibility to read and remember the workplace hazards, then watch for and avoid them while moving, setting up, and operating the machine.



Inspections

Decals Inspection with Symbols

Use the pictures on this page to verify that all decals are legible and in place. Below is a numerical list with quantities and descriptions.

Below is a numerical list with quantities and descriptions.

Part No.	Decal Description	Qty
28174	Label – Power to Platform, 230V	2
28235	Label – Power to Platform, 115V	2
43618	Label – Directional Arrows	1
43658	Label – Power to Charger, 230V	1
44980	Label – Power to Charger, 115V	1
44981	Label – Air Line to Platform	2
52475	Label – Transport Tie-down	4
72086	Label – Lifting Point	4
82474	Label – Use Safety Chock	2
82475	Label – Crushing Hazard, Outriggers	4
82476	Label – Electrocutation Hazard	2
82481	Label – Battery/Charger Safety	1
82487	Label – Read the Manual	2
82560	Label – Skin Injection Hazard	1
82562	Label – Crushing Hazard	4
82666	Label – Forklift Pocket	4
97719	Label – Safety Arm	1
114202	Label – Transport Diagram	2
114334	Label – Electrocutation Hazard, Plug	1
114337	Label – Tip-over Hazard, Limit Switch	1
114338	Label – Tip-over Hazard, Tilt Alarm	1
114371	Label – Outrigger Safety	1
133537	Label – Crushing Hazard	1
137605	Label – Emergency Stop, Platform Control	1
137656	Label – Drive/Steer Direction, Platform Control	1

Part No.	Decal Description	Qty
216031	Label – Runaway Hazard, Slope	1
229828	Warning – Hot Surface	1
236360	Overlay – Platform Control Panel (without outriggers)	1
237124	Label – Wheel Load, GS-2669DC	4
237125	Label – Wheel Load, GS-3369DC	4
237126	Label – Wheel Load, GS-4069DC	4
237127	Overlay – Platform Control Panel (with outriggers)	1
237924	Label – Tip-over Hazard, Batteries, J305	1
237925	Label – Tip-over Hazard, Batteries, T105	1
237926	Label – Outrigger Load	4
1263542	Label – Compartment Access	2
1281174	Label – Lanyard Anchorage Point, Fall Arrest/Fall Restrained	6
1281175	Label – Lanyard Anchorage Point, Fall Restrained	6
1283079	Label – Fall Hazard	1
1293166	Danger, Warning – Tip-over, Crush Hazard	1
1293217	Label – Danger, Electrocutation Hazard	2
1294398	Label – ANSI/CSA Compliant	1
1294688	Label – Platform Overload LED Indicator Light	1
1295449	Overlay – Ground Control Panel	1
1299285	Danger – Tip-over, Capacity, GS-2669	1
1299286	Danger – Tip-over, Capacity, GS-3369	1
1299287	Danger – Tip-over, Capacity, GS-4069	1
1301216	Label – Emergency Lowering	1
1302876	Label – SmartLink Update, GS-69	2

■ Shading indicates decal is hidden from view, i.e. under covers

* These decals are model, option or configuration specific.



Inspections

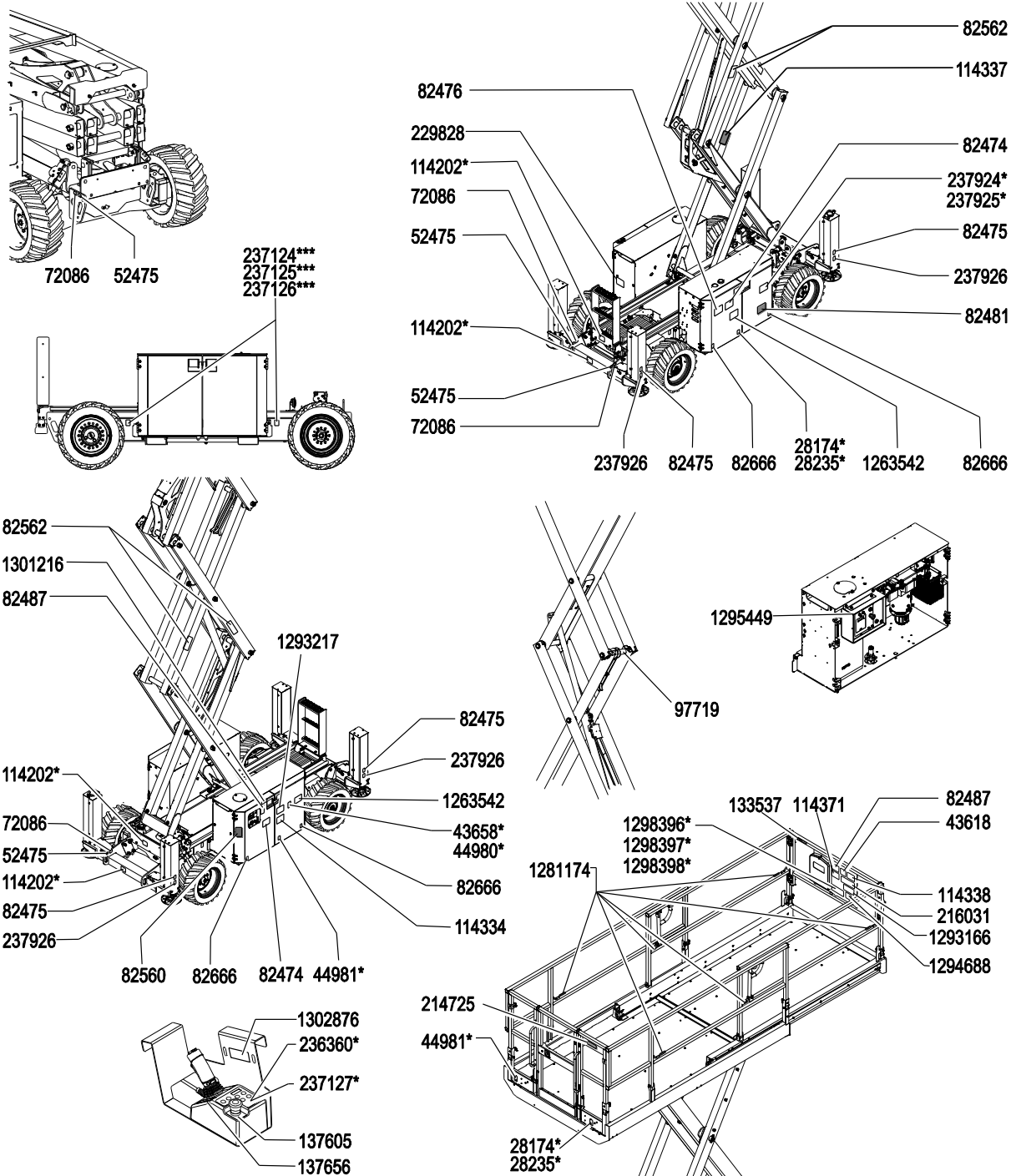

Operating Instructions



Do Not Operate Unless:

- ☑ You learn and practice the principles of safe machine operation contained in this operator's manual.
 - 1 Avoid hazardous situations.
 - 2 Always perform a pre-operation inspection.
 - 3 Always perform function tests prior to use.
 - 4 Inspect the workplace.
 - 5 **Only use the machine as it was intended.**

Fundamentals

The Operating Instructions section provides instructions for each aspect of machine operation. It is the operator's responsibility to follow all the safety rules and instructions in the operator's, safety, and responsibilities manuals.

Using the machine for anything other than lifting personnel, along with their tools and materials, to an aerial work site is unsafe and dangerous.

Only trained and authorized personnel should be permitted to operate a machine. If more than one operator is expected to use a machine at different times in the same work shift, they must all be qualified operators and are all expected to follow all safety rules and instructions in the operator's, safety, and responsibilities manuals. That means every new operator should perform a pre-operation inspection, function tests, and a workplace inspection before using the machine.



Operating Instructions

Emergency Stop

Push in the red Emergency Stop button to the off position at the ground controls or the platform controls to stop all functions.

Repair any function that operates when either red Emergency Stop button is pushed in.

Auxiliary Lowering

- 1 Turn the key switch to ground control.
- 2 Pull out the platform and ground red Emergency Stop button to the on position.
- 3 Move and hold the auxiliary lowering function enable toggle switch.
- 4 Move and hold the auxiliary lowering toggle switch.

Operation from Ground

- 1 Be sure the battery pack is connected before operating the machine.
- 2 Turn the key switch to ground control.
- 3 Pull out both ground and platform red Emergency Stop buttons to the on position.

To Position Platform

- 1 At the control panel, press and hold the lift function enable button.
- 2 Press the platform up or down button.

Drive and steer functions are not available from the ground controls.

Operation from Platform

- 1 Be sure the battery pack is connected before operating the machine.
- 2 Turn the key switch to platform control.
- 3 Pull out both ground and platform red Emergency Stop buttons to the on position.

To Position Platform

- 1 Press the lift function button. On the LCD screen, a circle below the lift function symbol will turn on.



If the control handle is not moved within seven seconds of pushing the lift function button, the circle below the lift function symbol will turn off and lift function will not operate. Press the lift function button again.

- 2 Press and hold the function enable switch on the control handle.
- 3 Move the control handle according to the markings on the control panel.

Operating Instructions

To Extend Outriggers

- 1 Press the outrigger function button. On the LCD screen, a circle below the outrigger function symbol will turn on.
- 2 Press and hold the function enable switch on the control handle.
- 3 Move the control handle in the direction indicated by the yellow arrow.

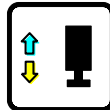

The outriggers will begin to extend. The individual outrigger indicator light will turn solid green as the corresponding outrigger makes contact with the ground. Continue moving the control handle until the lift enable indicator light turns green and a beep is heard. The machine is now level. When the lift error indicator light turns red, the up/down and drive functions are disabled. The lift error indicator light will turn red under the following conditions:

- Not all outriggers are in contact with the ground.
- All four outriggers are in contact with the ground but the machine is not level.
- Error code.

Note: If the outrigger enable and extend buttons are released too soon during extension, the outrigger indicator lights will continue to flash green, indicating the outriggers are not contacting the ground.

Note: If the outrigger lights are solid green, the machine may not be level or the outriggers may not be fully deployed if a long beep is not heard at the platform controls alarm.

To Retract Outriggers

- 1 Press the outrigger function button.
- 2 Press and hold the function enable switch on the control handle.
- 3 Move the control handle in the direction indicated by the blue arrow.

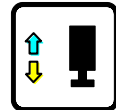

Release the control handle once the outriggers are off the ground. After approximately 5 seconds, the outrigger indicator lights will turn off. All functions are now restored.

Note: If the outrigger enable and retract buttons are released too soon during retraction, the outrigger indicator lights will flash green, indicating the outriggers are not fully retracted.

To Steer

- 1 Press the drive function button. On the LCD screen, a circle below the drive function symbol will turn on.

If the control handle is not moved within seven seconds of pushing the drive function button, the circle below the drive function symbol will turn off and drive function will not operate. Press the drive function button again.

- 2 Turn the steer wheels with the thumb rocker switch located on the top of the control handle.



Operating Instructions

To Drive

- 1 Press the drive function button. On the LCD screen, a circle below the drive function symbol will turn on.

If the control handle is not moved within seven seconds of pushing the drive function button, the circle below the drive function symbol will turn off and drive function will not operate. Press the drive function button again.

- 2 Press and hold the function enable switch on the control handle.
- 3 Increase speed: Slowly move the control handle off center.
Decrease speed: Slowly move the control handle toward center.
Stop: Return the control handle to center or release the function enable switch.

Use the color-coded direction arrows on the platform controls and on the platform to identify the direction the machine will travel.

Machine travel speed is restricted when the platform is raised.

Battery condition will affect machine performance. Machine drive speed and function speed will drop when the battery level indicator is flashing.

▲ Driving on a slope

Determine the uphill, downhill and side slope ratings for the machine and determine the slope grade.



Maximum slope rating, extension deck uphill (gradeability): 35% (19°)



Maximum slope rating, extension deck downhill: 15% (9°)



Maximum side slope rating: 35% (19°)

Note: Slope rating is subject to ground conditions and adequate traction.



Operating Instructions

To determine the slope grade:

Measure the slope with a digital inclinometer OR use the following procedure.

You will need:

- carpenter's level
- straight piece of wood, at least 3 feet/1 m long
- tape measure

Lay the piece of wood on the slope.

At the downhill end, lay the level on the top edge of the piece of wood and lift the end until the piece of wood is level.

While holding the piece of wood level, measure the vertical distance from the bottom of the piece of wood to the ground.

Divide the tape measure distance (rise) by the length of the piece of wood (run) and multiply by 100.

Example:

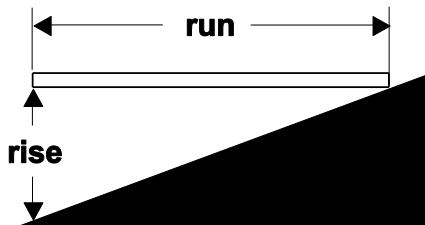

Piece of wood = 144 inches (3.6 m)

Run = 144 inches (3.6 m)

Rise = 12 inches (0.3 m)

$12 \text{ in} \div 144 \text{ in} = 0.083 \times 100 = 8.3\% \text{ grade}$

$0.3 \text{ m} \div 3.6 \text{ m} = 0.083 \times 100 = 8.3\% \text{ grade}$

If the slope exceeds the maximum slope or side slope rating, then the machine must be winched or transported up or down the slope. See Transport and Lifting section.

Platform Overload

If the platform controls LED diagnostic readout displays a flashing OL and the ground controls LCD diagnostic readout displays OL: Platform Overloaded, the platform is overloaded and no functions will operate. An alarm will sound.

- 1 Push in the Red Emergency stop button to the off position.
- 2 Remove weight from the platform.
- 3 Pull out the Red Emergency Stop button to the on position.

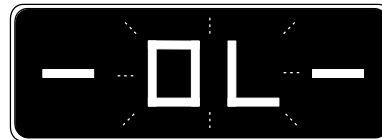

LED Readout



LCD Readout

Operating Instructions

Operational indicator codes

If the platform controls LED or ground controls LCD diagnostic readout displays an operational indicator code such as LL, the fault condition must be repaired or removed before resuming machine operation. Push in and pull out the red Emergency Stop button to reset the system.

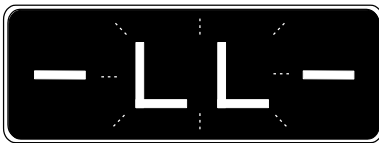

LED Readout

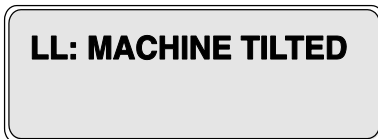

LCD Readout

Operational Indicator Codes

Code	Condition
LL	Off-Level
OL	Platform Overloaded
CH	Chassis Mode Operation
Nd	No Drive (option)
Ld	Lifting Disabled
F053	DCON RR Thermal Protection
F054	DCON LR Thermal Protection
F055	Traction Motor RR Fault: Motor Temp
F056	Traction Motor LR Fault: Motor Temp

For further information, please consult the appropriate Genie Service Manual. A code and a description of a code can also be viewed at the ground controls LCD display.

To reset thermal limit cutout

If the platform controls LED readout displays fault codes F053, F054, F055 or F056, the machine has overheated. The fault condition must be repaired or removed before resuming machine operation.

- 1 Push in the red Emergency Stop button to the off position.
- 2 Allow the machine to cool for approximately 5 minutes before resuming machine operation.
- 3 Pull out the red Emergency Stop button to the on position.

Operation from Ground with Controller

Maintain safe distances between the operator, machine and fixed objects.

Be aware of the direction the machine will travel when using the controller.

Operating Instructions

Battery Level Indicator

Use the LED diagnostic readout to determine the battery level.

Note: When a blinking LO code appears on the platform controls LED display, the machine must be taken out of service and charged, otherwise all machine functions will be disabled.

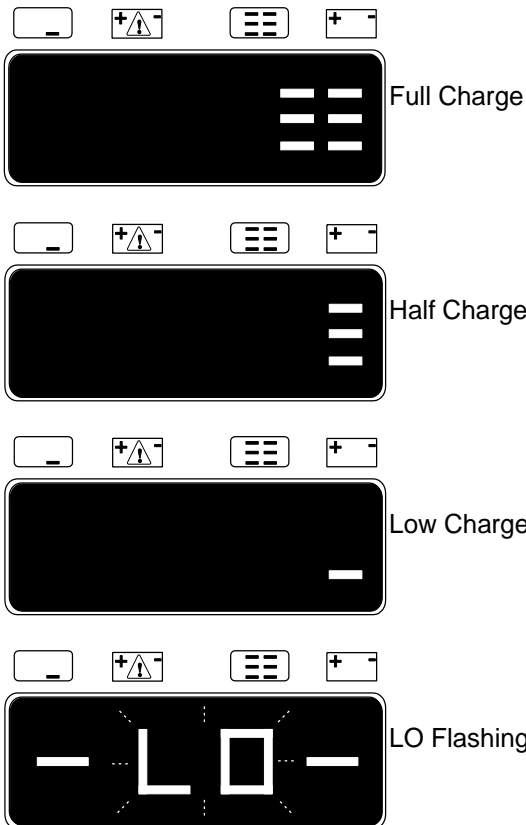

After Each Use

- 1 Select a safe parking location—firm level surface, clear of obstruction and traffic.
- 2 Lower the platform.
- 3 Turn the key switch to the off position and remove the key to secure from unauthorized use.
- 4 Charge the batteries.

Tilt Sensor Activation Settings

Chassis Angle on Wheels	
Chassis Angle (side to side)	2°
Chassis Angle (front to back)	3°
Chassis Angle on Outriggers	
Chassis Angle (side to side)	0.8°
Chassis Angle (front to back)	3°

When the machine is On Incline and elevated above the down limit height, the tilt alarm sounds and the drive and lift functions are disabled.

Lower the machine below the down limit height to restore drive and lift functionality.



Operating Instructions

How to Use the Safety Arm

- 1 Raise the platform approximately 8 ft / 2.4 m from the ground.
- 2 Rotate the safety arm away from the machine and let it hang down.
- 3 Lower the platform until the safety arm rests securely on the link. Keep clear of the safety arm when lowering the platform.

To Extend and Retract Platform

- 1 Lift the platform extension lock handles to the horizontal position.
- 2 Push the platform extension lock handles to extend the platform to the desired position.

Do not stand on the platform extension while trying to extend it.

- 3 Lower the platform extension lock handles and make sure the extension deck is locked.

Operating Instructions



Battery and Charger Instructions

Observe and Obey:

- Do not use an external charger or booster battery.
- Charge the battery in a well-ventilated area.
- Use proper AC input voltage for charging as indicated on the charger.
- Use only a Genie authorized battery and charger.

To Charge Battery

- 1 Be sure the batteries are connected before charging the batteries.
- 2 Open the battery compartment. The compartment should remain open for the entire charging cycle.

Maintenance-free batteries

- 1 Connect the battery charger to a grounded AC circuit.
- 2 The charger will indicate when the battery is fully charged.

Standard Batteries

- 1 Remove the battery vent caps and check the battery acid level. If necessary, add only enough distilled water to cover the plates. Do not overfill prior to the charge cycle.
- 2 Replace the battery vent caps.
- 3 Connect the battery charger to a grounded AC circuit.
- 4 The charger will indicate when the battery is fully charged.
- 5 Check the battery acid level when the charging cycle is complete. Replenish with distilled water to the bottom of the fill tube. Do not overfill.

Dry Battery Filling and Charging Instructions

- 1 Remove the battery vent caps and permanently remove the plastic seal from the battery vent openings.
- 2 Fill each cell with battery acid (electrolyte) until the level is sufficient to cover the plates.

Do not fill to maximum level until the battery charge cycle is complete. Overfilling can cause the battery acid to overflow during charging. Neutralize battery acid spills with baking soda and water.

- 3 Install the battery vent caps.
- 4 Charge the battery.
- 5 Check the battery acid level when the charging cycle is complete. Replenish with distilled water to the bottom of the fill tube. Do not overfill.

Transport and Lifting Instructions



Observe and Obey:

- ☑ Genie provides this securement information as a recommendation. Drivers are solely responsible for making sure machines are properly secured and the correct trailer is selected pursuant to US Department of Transportation regulations, other localized regulations, and their company policy.
- ☑ Genie customers needing to containerize any lift or Genie product should source a qualified freight forwarder with expertise in preparing, loading and securing construction and lifting equipment for international shipment.
- ☑ Only qualified mobile elevating work platform operators should move the machine on or off the truck.
- ☑ The transport vehicle must be parked on a level surface.
- ☑ The transport vehicle must be secured to prevent rolling while the machine is being loaded.
- ☑ Be sure the vehicle capacity, loading surfaces and chains or straps are sufficient to withstand the machine weight. Genie lifts are very heavy relative to their size. See the serial label for the machine weight.
- ☑ The machine must be on a level surface or secured before releasing the brakes.

- ☑ Do not drive the machine on a slope that exceeds the uphill, downhill or side slope rating. See Driving on a Slope in the Operating Instructions section.
- ☑ If the slope of the transport vehicle bed exceeds the maximum slope rating, the machine must be loaded and unloaded using a winch as described in the brake release operation.

Free-wheel Configuration for Winching

Chock the wheels to prevent the machine from rolling.

All models: Release the wheel brakes by turning over the two rear torque hub disconnect caps.

Be sure the winch line is properly secured to the drive chassis tie points and the path is clear of all obstructions.

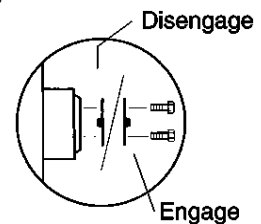

Reverse the procedures described to re-engage the brakes.

Chock the wheels to prevent the machine from rolling.

Transport and Lifting Instructions

Securing to Truck or Trailer for Transit

Always chock the machine wheels in preparation for transport.

Retract and secure the extension deck.

Use the tie-down points on the chassis for anchoring down to the transport surface.

Use a minimum of 2 chains or straps.

Use chains or straps of ample load capacity.

Turn the key switch to the off position and remove the key before transporting.

Inspect the entire machine for loose or unsecured items.

If the railings have been folded down, secure them with straps before transporting.

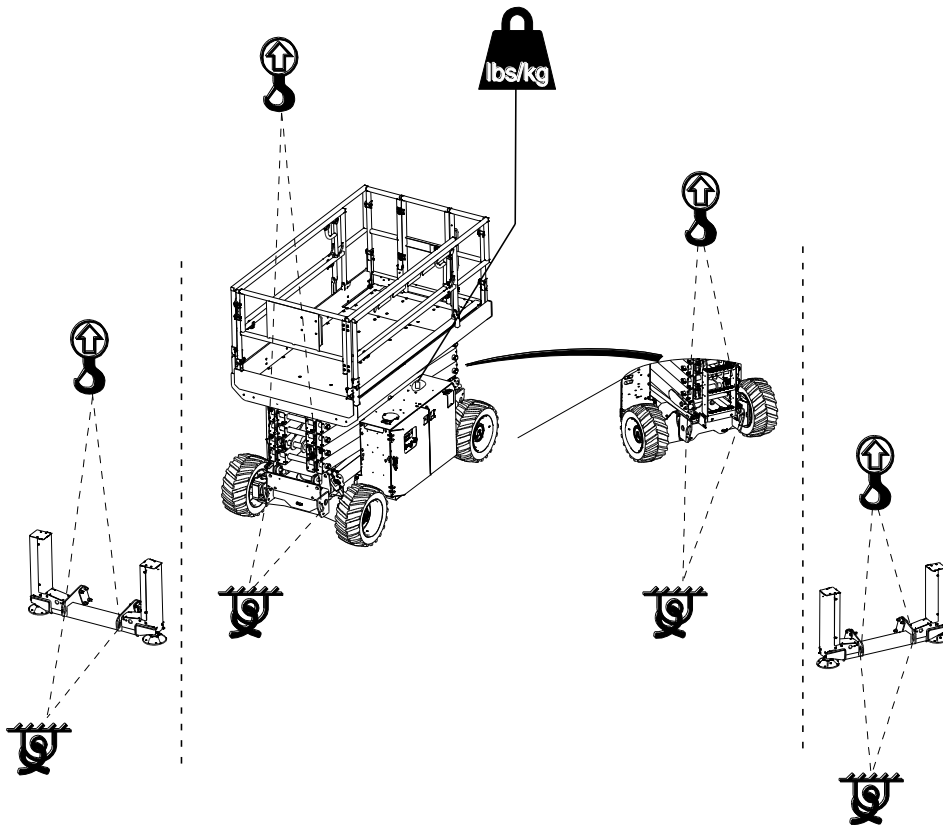

Transport and Lifting Instructions



Observe and Obey:

- ☑ Only qualified riggers should rig and lift the machine.
- ☑ Be sure the crane capacity, loading surfaces and straps or lines are sufficient to withstand the machine weight. See the serial label for the machine weight.

Lifting Instructions

Fully lower the platform. Be sure the extension deck, controls and component trays are secure. Remove all loose items on the machine.

Determine the center of gravity of your machine using the table and the picture on this page.

Attach the rigging only to the designated lifting points on the machine.

Adjust the rigging to prevent damage to the machine and to keep the machine level.

Center of gravity	X Axis	Y Axis
GS-2669DC without outriggers	38.3 in 97.3 cm	29.9 in 76 cm
GS-3369DC without outriggers	42.1 in 106.9 cm	31.5 in 80 cm
GS-4069DC without outriggers	39.2 in 99.6 cm	30.7 in 78 cm
GS-2669DC with outriggers	38.9 in 99 cm	29.3 in 74.4 cm
GS-3669DC with outriggers	42.3 in 107.4 cm	30.7 in 78 cm
GS-4069DC with outriggers	39.6 in 101 cm	30.2 in 77.cm

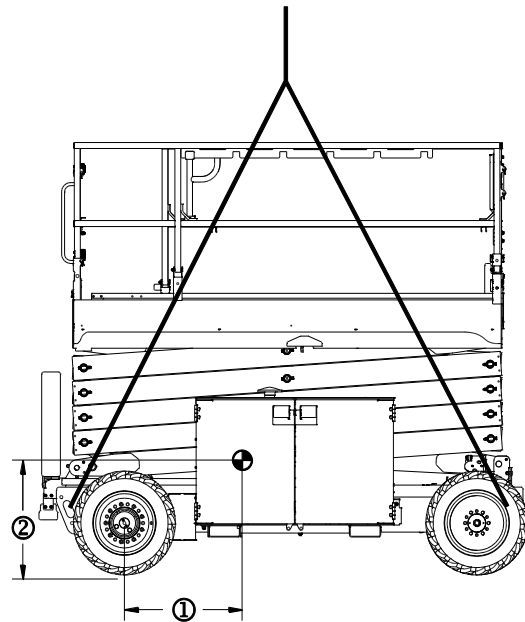

1 = X Axis

2 = Y Axis

Maintenance



Observe and Obey:

- ☑ Only routine maintenance items specified in this manual shall be performed by the operator.
- ☑ Scheduled maintenance inspections shall be completed by qualified service technicians, according to the manufacturer's specifications and the requirements specified in the responsibilities manual.
- ☑ Use only Genie approved replacement parts.

Maintenance Symbols Legend

The following symbols have been used in this manual to help communicate the intent of the instructions. When one or more of the symbols appear at the beginning of a maintenance procedure, it conveys the meaning below.



Indicates that tools will be required to perform this procedure.



Indicates that new parts will be required to perform this procedure.

Check the Hydraulic Oil Level



Maintaining the hydraulic oil at the proper level is essential to machine operation. Improper hydraulic oil levels can damage hydraulic components. Daily checks allow the inspector to identify changes in oil level that might indicate the presence of hydraulic system problems.

- 1 Be sure that the platform is in the stowed position.
- 2 Visually inspect the sight gauge located on the side of the hydraulic oil tank.
- ⊙ Result: The hydraulic oil level should be within the top 2 inches / 5 cm of the sight gauge.
- 3 Add oil as needed. Do not overfill.

Hydraulic oil specifications

Hydraulic oil type	Chevron Rando HD equivalent
--------------------	-----------------------------



Maintenance

Check the Batteries



Proper battery condition is essential to good machine performance and operational safety. Improper fluid levels or damaged cables and connections can result in component damage and hazardous conditions.

- ⚠ **Electrocution hazard.** Contact with hot or live circuits may result in death or serious injury. Remove all rings, watches and other jewelry.
- ⚠ **Bodily injury hazard.** Batteries contain acid. Avoid spilling or contacting battery acid. Neutralize battery acid spills with baking soda and water.

Note: Perform this test after fully charging the batteries.

- 1 Put on protective clothing and eye wear.
- 2 Be sure that the battery cable connections are tight and free of corrosion.
- 3 Be sure that the battery hold-down brackets are in place and secure.

Note: Adding terminal protectors and a corrosion preventative sealant will help eliminate the corrosion on the battery terminals and cables.

Scheduled Maintenance

Maintenance performed quarterly, annually and every two years must be completed by a person trained and qualified to perform maintenance on this machine according to the procedures found in the service manual for this machine.

Machines that have been out of service for more than three months must receive the quarterly inspection before they are put back into service.



Specifications

GS-2669DC		
Height, working maximum	32 ft	9.8 m
Height, platform maximum	26.2 ft	10 m
Height, stowed maximum, rails up	102 in	2.59 m
Height, stowed maximum, rails lowered	75.5 in	1.92 m
Height, guard rails	58 in	1.47 m
Width	69 in	1.75 m
Length, platform retracted	123 in	3.12 m
Length, platform retracted, models with outriggers	148 in	3.76 m
Length, platform extended	177.5 in	4.51 m
Length, platform extended, models with outriggers	189.5 in	4.81 m
Length, outside platform extended	170 in	4.32 m
Maximum load capacity	1500 lbs	680 kg
Maximum wind speed	28 mph	12.5 m/s
Wheelbase	90 in	2.29 m
Turning radius (outside)	181.2 in	4.6 m
Turning radius (inside)	83 in	2.11 m
Ground clearance	9.5 in	24 cm
Weight	7946 lbs	3604 kg
(Machine weights vary with option configurations. See serial label for specific machine weight.)		
Controls	Proportional	
AC outlet in platform	Standard	
Platform dimensions		
Platform length x width	110 in x 63 in	2.79 x 1.6 m
Platform extension length	60 in	152.4 cm
Drive speeds		
Stowed, maximum	3.5 mph	5.63 km/h
Platform raised, maximum	0.3 mph 40 ft/90 sec	0.48 km/h 12.2 m/90 sec
Maximum hydraulic pressure (functions)	3500 psi	241 bar
Tire size	26 x 12 in	
Total vibration value to which the hand/arm system is subjected does not exceed 2.5 m/s ² .		
Highest root mean square value of weighted acceleration to which the whole body is subjected does not exceed 1.6 ft/s ² or 0.5 m/s ² .		

Airborne noise emissions		
Sound pressure level at ground workstation	<70 dBA	
Sound pressure level at platform workstation	<70 dBA	
Maximum slope rating, stowed position		
Extension deck uphill	35% (19°)	
Extension deck downhill	15% (9°)	
Side slope	35% (19°)	
Note: Slope rating is subject to ground conditions with one person in the platform and adequate traction. Additional platform weight may reduce slope rating.		
Floor loading information		
Tire load maximum	3334 lbs	1512 kg
Outrigger load, maximum	3175 lbs	1440 kg
Tire contact pressure	71.9 psi	5.06 kg/cm ² 496 kPa
Outrigger contact pressure	36.8 psi	2.59 kg/cm ² 254 kPa
Occupied floor pressure	173 psf	846 kg/m ² 8.3 kPa
Note: Floor loading information is approximate and does not incorporate different option configurations. It should be used only with adequate safety factors.		
Operating temperature		
For ambient temperatures consistently below 0°F (-17°C) - use Chevron Aviation A Arctic hydraulic fluid or equivalent.		
For ambient temperatures consistently above 0°F (-17°C) - use Chevron Rando HD MV hydraulic fluid or equivalent.		
For operating temperatures consistently above 205°F (96°C) - use Shell Tellus S2 V 46.		

Continuous improvement of our products is a Genie policy. Product specifications are subject to change without notice or obligation.



Specifications

GS-3369DC		
Height, working maximum	39 ft	11.9 m
Height, platform maximum	32.7 ft	10 m
Height, stowed maximum, rails up	102 in	2.59 m
Height, stowed maximum, rails lowered	75.5 in	1.92 m
Height, guard rails	58 in	1.47 m
Width	69 in	1.75 m
Length, platform retracted	123 in	3.12 m
Length, platform retracted, models with outriggers	148 in	3.76 m
Length, platform extended	177.5 in	4.51 m
Length, platform extended, models with outriggers	189.5 in	4.81 m
Length, outside platform extended	170 in	4.32 m
Maximum load capacity	1000 lbs	454 kg
Maximum wind speed	28 mph	12.5 m/s
Wheelbase	90 in	2.29 m
Turning radius (outside)	181.2 in	4.6 m
Turning radius (inside)	83 in	2.11 m
Ground clearance	9.5 in	24 cm
Weight	7687 lbs	3490 kg
(Machine weights vary with option configurations. See serial label for specific machine weight.)		
Controls	Proportional	
AC outlet in platform	Standard	
Platform dimensions		
Platform length x width	110 in x 63 in	2.79 x 1.6 m
Platform extension length	60 in	152.4 cm
Drive speeds		
Stowed, maximum	3.5 mph	5.63 km/h
Platform raised, maximum	0.3 mph	0.48 km/h
	40 ft/90 sec	12.2 m/90 sec
Maximum hydraulic pressure (functions)	3500 psi	241 bar
Tire size	26 x 12 in	
Total vibration value to which the hand/arm system is subjected does not exceed 2.5 m/s ² .		
Highest root mean square value of weighted acceleration to which the whole body is subjected does not exceed 1.6 ft/s ² or 0.5 m/s ² .		

Airborne noise emissions		
Sound pressure level at ground workstation	<70 dBA	
Sound pressure level at platform workstation	<70 dBA	
Maximum slope rating, stowed position		
Extension deck uphill	35% (19°)	
Extension deck downhill	15% (9°)	
Side slope	35% (19°)	
Note: Slope rating is subject to ground conditions with one person in the platform and adequate traction. Additional platform weight may reduce slope rating.		
Floor loading information		
Tire load maximum	3199 lbs	1451 kg
Outrigger load, maximum	3421 lbs	1552 kg
Tire contact pressure	76.1 psi	5.35 kg/cm ² 524 kPa
Outrigger contact pressure	38.9 psi	2.74 kg/cm ² 268 kPa
Occupied floor pressure	172 psf	838 kg/m ² 8.22 kPa
Note: Floor loading information is approximate and does not incorporate different option configurations. It should be used only with adequate safety factors.		
Operating temperature		
For ambient temperatures consistently below 0°F (-17°C) - use Chevron Aviation A Arctic hydraulic fluid or equivalent.		
For ambient temperatures consistently above 0°F (-17°C) - use Chevron Rando HD MV hydraulic fluid or equivalent.		
For operating temperatures consistently above 205°F (96°C) - use Shell Tellus S2 V 46.		
Continuous improvement of our products is a Genie policy. Product specifications are subject to change without notice or obligation.		



Specifications

GS-4069DC		
Height, working maximum	46 ft	14 m
Height, platform maximum	40.3 ft	12.3 m
Height, stowed maximum, rails up	108 in	2.74 m
Height, stowed maximum, rails lowered	82 in	2.08 m
Height, guard rails	65 in	1.65 m
Width	69 in	1.75 m
Length, platform retracted	123 in	3.12 m
Length, platform retracted, models with outriggers	148 in	3.76 m
Length, platform extended	177.5 in	4.51 m
Length, platform extended, models with outriggers	189.5 in	4.81 m
Length, outside platform extended	170 in	4.32 m
Maximum load capacity	800 lbs	363 kg
Maximum wind speed	28 mph	12.5 m/s
Wheelbase	90 in	2.29 m
Turning radius (outside)	181.2 in	4.6 m
Turning radius (inside)	83 in	2.11 m
Ground clearance	9.5 in	24 cm
Weight	10,948 lbs	4966 kg
(Machine weights vary with option configurations. See serial label for specific machine weight.)		
Controls	Proportional	
AC outlet in platform	Standard	
Platform dimensions		
Platform length x width	110 in x 63 in	2.79 x 1.6 m
Platform extension length	60 in	152.4 cm
Drive speeds		
Stowed, maximum	3.5 mph	5.63 km/h
Platform raised, maximum	0.3 mph	0.48 km/h
	40 ft/90 sec	12.2 m/90 sec
Maximum hydraulic pressure (functions)	3500 psi	241 bar
Tire size	26 x 12 in	
Total vibration value to which the hand/arm system is subjected does not exceed 2.5 m/s ² .		
Highest root mean square value of weighted acceleration to which the whole body is subjected does not exceed 1.6 ft/s ² or 0.5 m/s ² .		

Airborne noise emissions		
Sound pressure level at ground workstation	<70 dBA	
Sound pressure level at platform workstation	<70 dBA	
Maximum slope rating, stowed position		
Extension deck uphill	35% (19°)	
Extension deck downhill	15% (9°)	
Side slope	35% (19°)	
Note: Slope rating is subject to ground conditions with one person in the platform and adequate traction. Additional platform weight may reduce slope rating.		
Floor loading information		
Tire load maximum	3811 lbs	1729 kg
Outrigger load, maximum	3757 lbs	1704 kg
Tire contact pressure	94.9 psi	6.68 kg/cm ² 654 kPa
Outrigger contact pressure	48.3 psi	3.42 kg/cm ² 335 kPa
Occupied floor pressure	214 psf	1045 kg/m ² 10.25 kPa
Note: Floor loading information is approximate and does not incorporate different option configurations. It should be used only with adequate safety factors.		
Operating temperature		
For ambient temperatures consistently below 0°F (-17°C) - use Chevron Aviation A Arctic hydraulic fluid or equivalent.		
For ambient temperatures consistently above 0°F (-17°C) - use Chevron Rando HD MV hydraulic fluid or equivalent.		
For operating temperatures consistently above 205°F (96°C) - use Shell Tellus S2 V 46.		
Continuous improvement of our products is a Genie policy. Product specifications are subject to change without notice or obligation.		



Specifications

Contents of EC Declaration of Conformity

<Manufacturer's name> hereby declares that the machinery described below complies with the provisions of the following Directives:

1. EC Directive 2006/42/EC, Machinery Directive, under consideration of harmonized European standard EN280 as described in EC type-examination certificate <variable field> issued by:

Kuiper Certificering B.V.
Van Slingelandtstraat 75, 7331NM
Apeldoorn
Netherlands
NB number 2842

2. EC Directive EMC: 2014/30/EU, under consideration of harmonized European standard EN 61000-6-2 and EN 61000-6-4

3. EC Directive 2000/14/EC, Noise Directive, under consideration of Annex V and harmonized standard EN ISO 3744, internal combustion engine only.

Test Report:

This machine has been tested and passed the following categories per EN 280:2013+A1:2015 clause 6.3 prior to entering the market:

1. BRAKES: Brakes working properly in forward and reverse.
2. OVERLOAD: Overload tested at XXX% rated load.
3. FUNCTIONAL: Smooth operation at XXX% rated load.
4. FUNCTIONAL: All safety devices working correctly.
5. FUNCTIONAL: Speeds set within permitted specification.

Model / Type: <machine type>	Manufacture Date: <variable field>
Description: <machine classification>	Country of Manufacture: <variable field>
Model: <model name>	Net Installed Power: <only for IC machines>
Serial Number: <variable field>	Guaranteed Sound Power Level: <only for IC machines>
VIN: <where applicable>	
Manufacturer: <Manufacturer's name>	Authorized Representative: Genie Industries B.V Boekerman 5, 4751 XK Oud Gastel, The Netherlands
Empowered signatory:	Place of Issue: <variable field>
	Date of Issue: <variable field>



Distributed By: